

General Description

The AOZ8201 is a one-line transient voltage suppressor diode designed to protect voltage sensitive electronics from high transient conditions and ESD. This state-of-the-art device utilizes AOS leading edge Trench Vertical Structure [TVS]²™ technology for superior clamping performance.

This device incorporates one TVS diode in an ultra-small SOD523 package. During transient conditions, the one-line TVS diode directs the transient to ground. It may be used to meet the ESD immunity requirements of IEC 61000-4-2, Level 4 (±15kV air, ±8kV contact discharge).

The AOZ8201 comes in an RoHS compliant SOD523 package and is rated over a -40°C to +85°C ambient temperature range.

The ultra-small 1.6 x 0.8 x 0.6mm SOD523 package makes it ideal for applications where PCB space is a premium. The small size and high ESD protection makes it ideal for protecting voltage sensitive electronics from high transient conditions and ESD.

Features

- ESD protection for high-speed data lines:
 - Exceeds: IEC 61000-4-2 (ESD) ±28kV (air), ±28kV (contact)
 - Human Body Model (HBM) ±30kV
- Trench Vertical Structure [TVS]²™ based technology used to achieve excellent ESD clamping performance
- Small package saves board space
- Low insertion loss
- Low clamping voltage
- Low operating voltage
- Green product

Applications

- Portable handheld devices
- Keypads, data lines, buttons
- Notebook computers
- Digital Cameras
- Portable GPS
- MP3 players



Typical Application

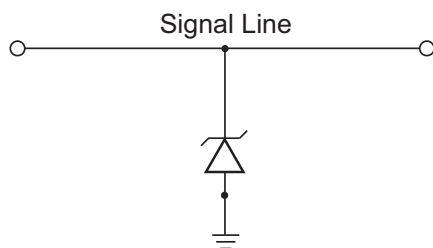

Unidirection Protection of Single Line

Pin Configuration



Ordering Information

Part Number	Ambient Temperature Range	Package	Environmental
AOZ8201NI-05L	-40°C to +85°C	SOD523	RoHS Compliant Green Product
AOZ8201NI-12L			



All AOS products are offered in packages with Pb-free plating and compliant to RoHS standards. Parts marked as Green Products (with "L" suffix) use reduced levels of Halogens, and are also RoHS compliant. Please visit www.aosmd.com/web/quality/rohs_compliant.jsp for additional information.

Absolute Maximum Ratings

Exceeding the Absolute Maximum ratings may damage the device.

Parameter	Rating
VP – VN	5V
Peak Pulse Current (I _{PP}), t _p = 8/20μs	5A
Storage Temperature (T _S)	-65°C to +150°C
ESD Rating per IEC61000-4-2, Contact ⁽¹⁾	±28kV
ESD Rating per IEC61000-4-2, Air ⁽¹⁾	±28kV
ESD Rating per Human Body Model ⁽²⁾	±30kV

Notes:

- IEC 61000-4-2 discharge with C_{Discharge} = 150pF, R_{Discharge} = 330Ω.
- Human Body Discharge per MIL-STD-883, Method 3015 C_{Discharge} = 100pF, R_{Discharge} = 1.5kΩ.

Maximum Operating Ratings

Parameter	Rating
Junction Temperature (T _J)	-40°C to +85°C

Electrical Characteristics

T_A = 25°C unless otherwise specified.

Symbol	Parameter	Symbol	Parameter
I _{PP}	Maximum Reverse Peak Pulse Current	V _{BR}	Breakdown Voltage @ I _T = 1mA
V _{CL}	Clamping Voltage	I _T	Test Current = 1mA
V _{RWM}	Working Reverse Voltage	P _{pk}	Peak Power Dissipation
I _R	Maximum Reverse Leakage Current	C _J	Max. Capacitance @ V _R = 0 and f = 1MHz

Electrical Characteristics

T_A = 25°C unless otherwise noted, V_F = 0.9V Max. @ I_F = 10mA for all types

Device	Device Marking	V _{RWM} (V) Max.	V _{BR} (V) Max.	I _R (μA) Max.	V _F (V) Typ.	V _{CL} Max.			C _J (pF) Max.
						I _{PP} = 1A	I _{PP} = 5A	I _{PP} = 12A	
AOZ8201NI-05L	C	5.0	6.0	0.1	0.75	8.00	9.00	10.00	16
AOZ8201NI-12L	D	12.0	15.0	0.1	0.75	18.00	20.00	21.00	30

Typical Performance Characteristics

Clamping Voltage vs. Peak Pulse Current
(tperiod = 100ns, tr = 1ns)

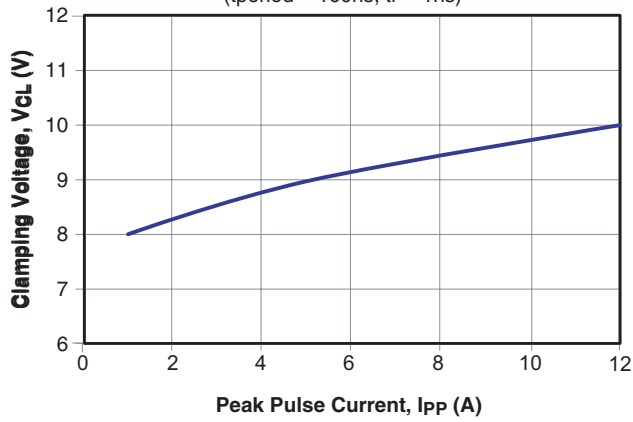

Forward Voltage vs. Forward Current
(tperiod = 100ns, tr = 1ns)

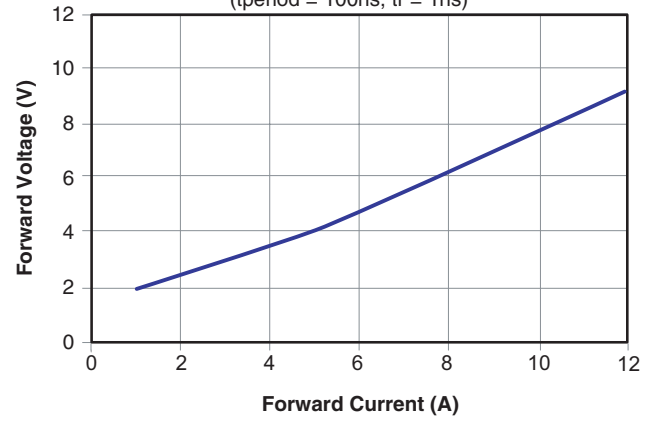

I/O – Gnd Insertion Loss (S21) vs. Frequency
($V_p = 3.3V$)

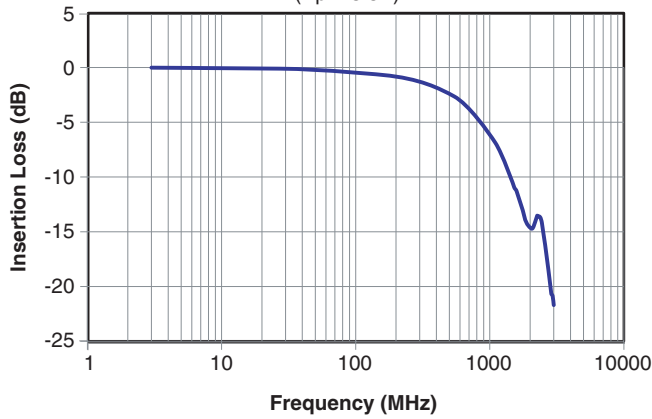

Capacitance vs. Reverse Bias

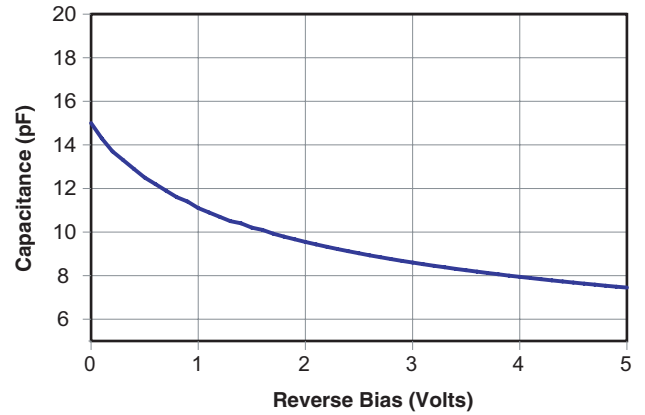

Analog Crosstalk (I/O–I/O) vs. Frequency

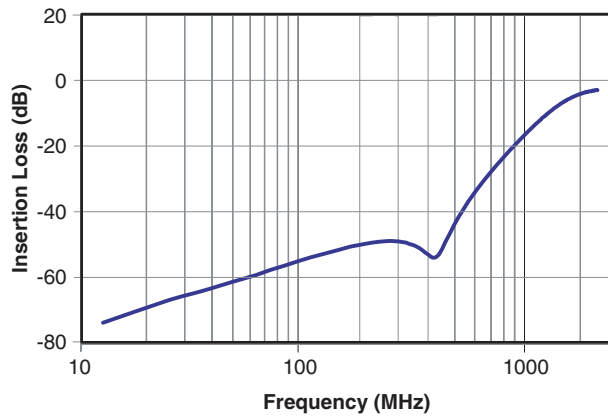

Package Dimensions, SOD523

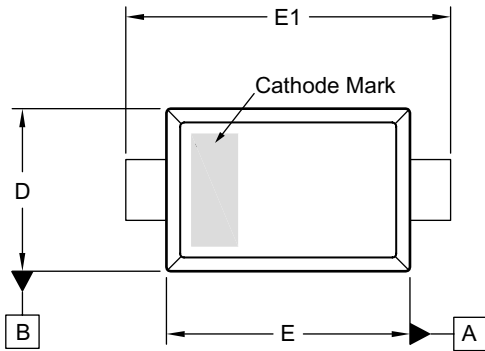

TOP VIEW

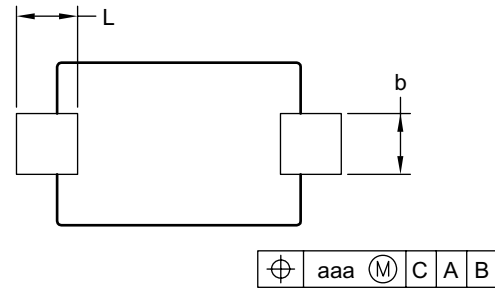

BOTTOM VIEW

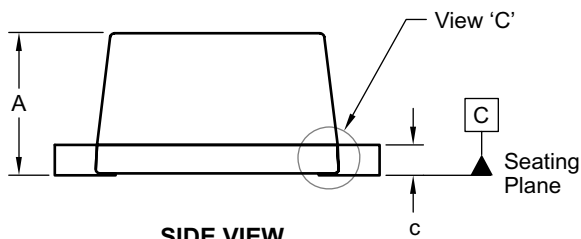

SIDE VIEW

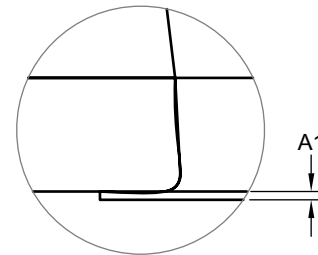

VIEW 'C'

RECOMMENDED LAND PATTERN

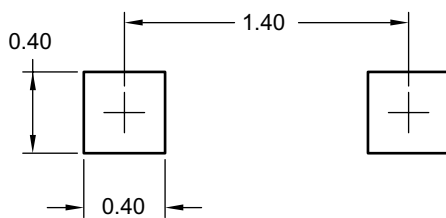

UNIT: mm

Dimensions in millimeters

Symbols	Min.	Nom.	Max.
A	0.50	0.60	0.70
A1	0.00	—	0.05
b	0.25	0.30	0.35
c	0.07	—	0.20
D	0.70	0.80	0.90
E	1.10	1.20	1.30
E1	1.50	1.60	1.70
L	0.25	0.30	0.40
aaa	0.08		

Dimensions in inches

Symbols	Min.	Nom.	Max.
A	0.020	0.024	0.028
A1	0.00	—	0.002
b	0.010	0.012	0.014
c	0.003	—	0.008
D	0.028	0.031	0.035
E	0.043	0.047	0.051
E1	0.059	0.063	0.067
L	0.010	0.012	0.016
aaa	0.003		

Notes:

1. All Dimensions are in millimeters.
2. Dimensions are inclusive of plating.
3. Controlling dimension is millimeter, converted inch dimensions are not necessarily exact.
4. The cathode mark is optional.
5. Package body sizes exclude mold flash and gate burrs. Mold flash at the non-lead sides should be less than 3 mils each.

Tape and Reel Dimensions, SOD523

Tape

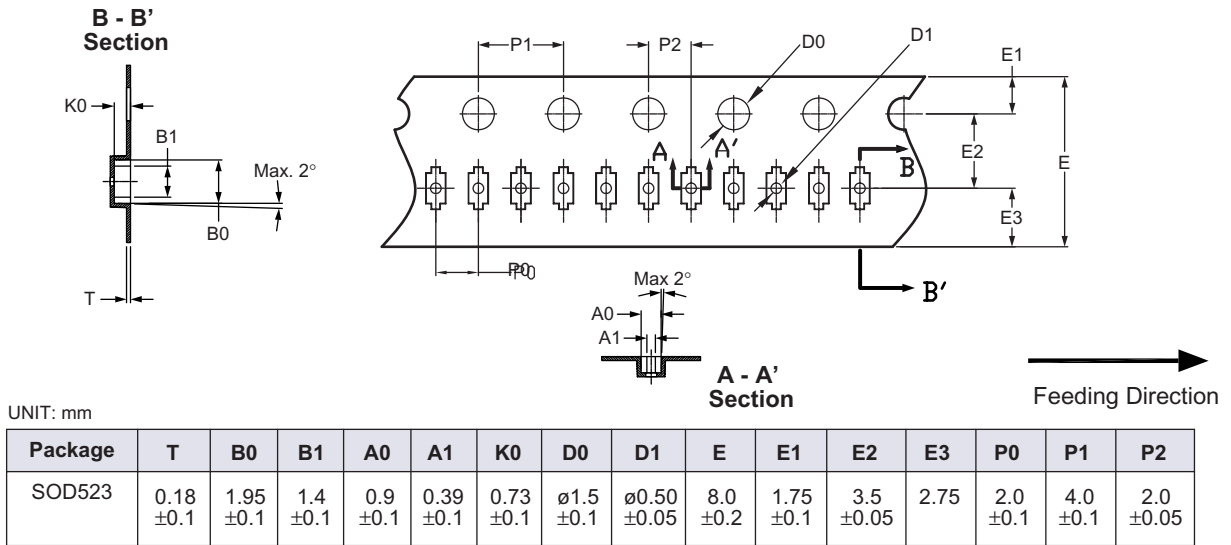

Reel

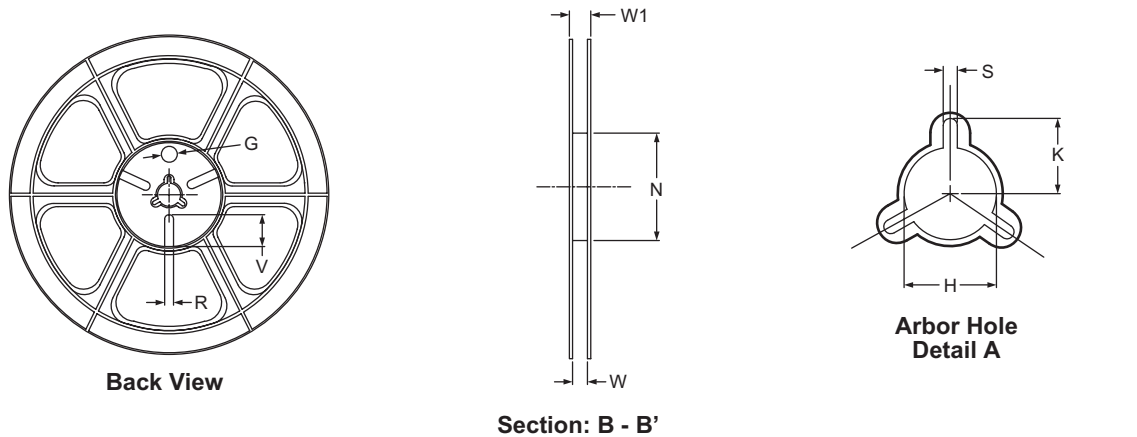

Leader/Trailer and Orientation

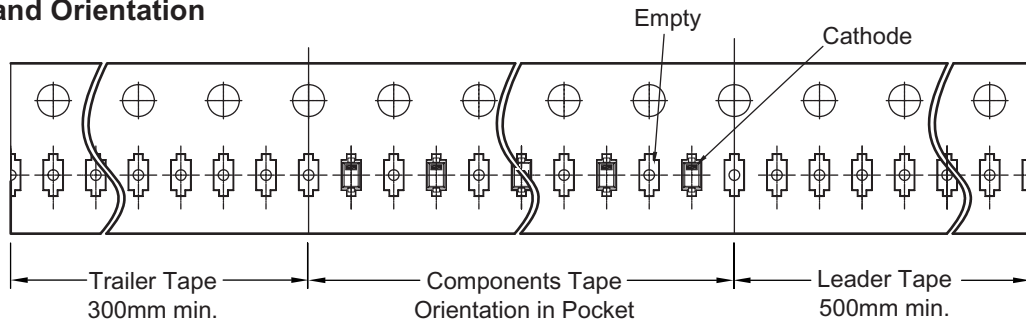

Part Marking

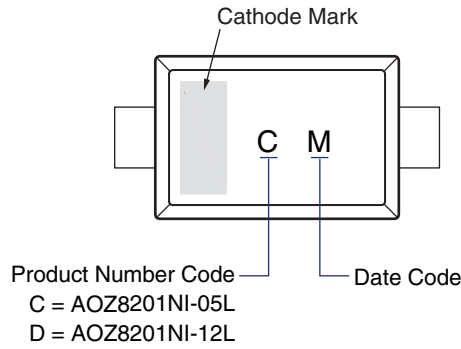

This data sheet contains preliminary data; supplementary data may be published at a later date. Alpha & Omega Semiconductor reserves the right to make changes at any time without notice.

LIFE SUPPORT POLICY

ALPHA & OMEGA SEMICONDUCTOR PRODUCTS ARE NOT AUTHORIZED FOR USE AS CRITICAL COMPONENTS IN LIFE SUPPORT DEVICES OR SYSTEMS.

As used herein:

- | | |
|---|---|
| <p>1. Life support devices or systems are devices or systems which, (a) are intended for surgical implant into the body or (b) support or sustain life, and (c) whose failure to perform when properly used in accordance with instructions for use provided in the labeling, can be reasonably expected to result in a significant injury of the user.</p> | <p>2. A critical component in any component of a life support, device, or system whose failure to perform can be reasonably expected to cause the failure of the life support device or system, or to affect its safety or effectiveness.</p> |
|---|---|